

ST.

ST.

ST.

MARKET

ISLAND

AVE.

J

ST.

K

ST.

MICROFILMED
JAN 24 1968

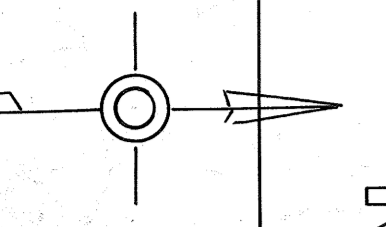
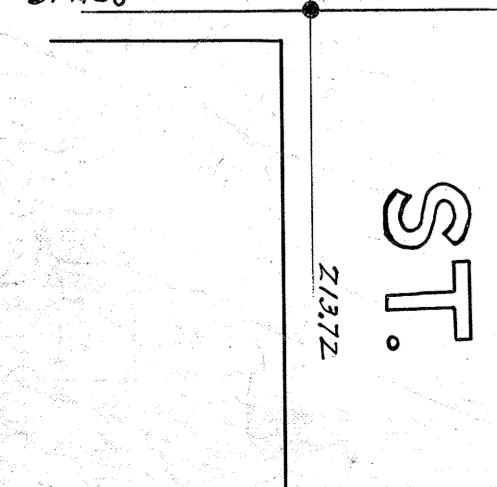
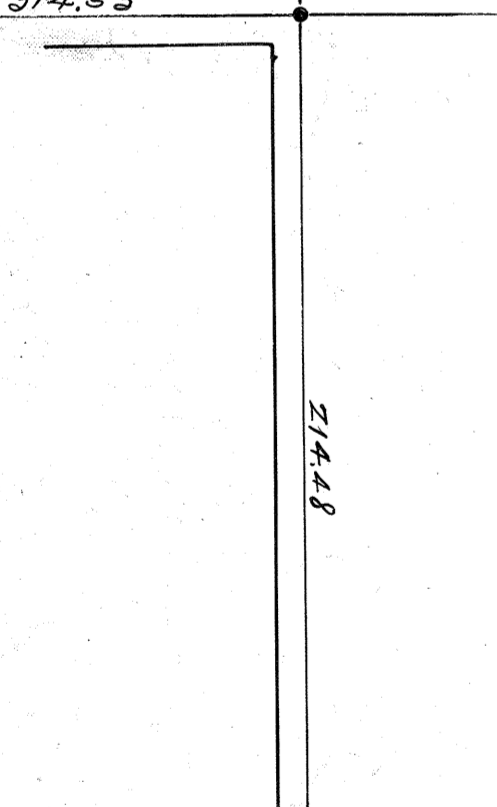
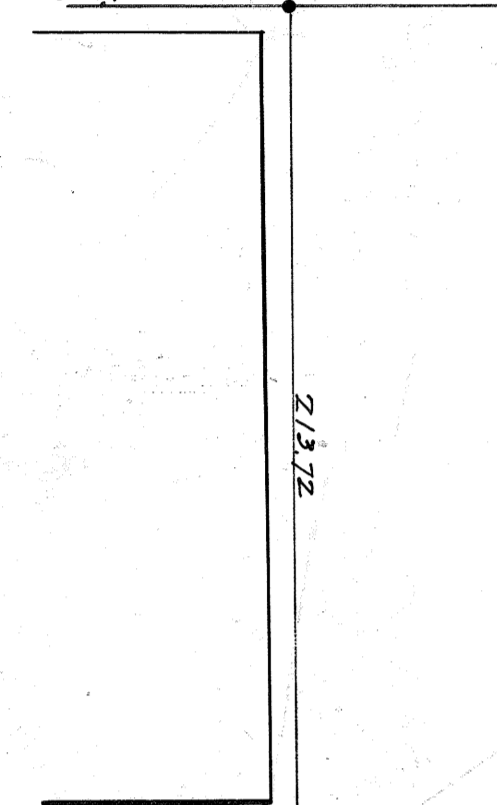
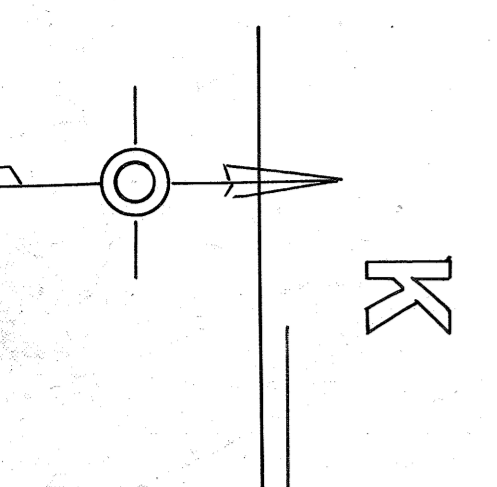
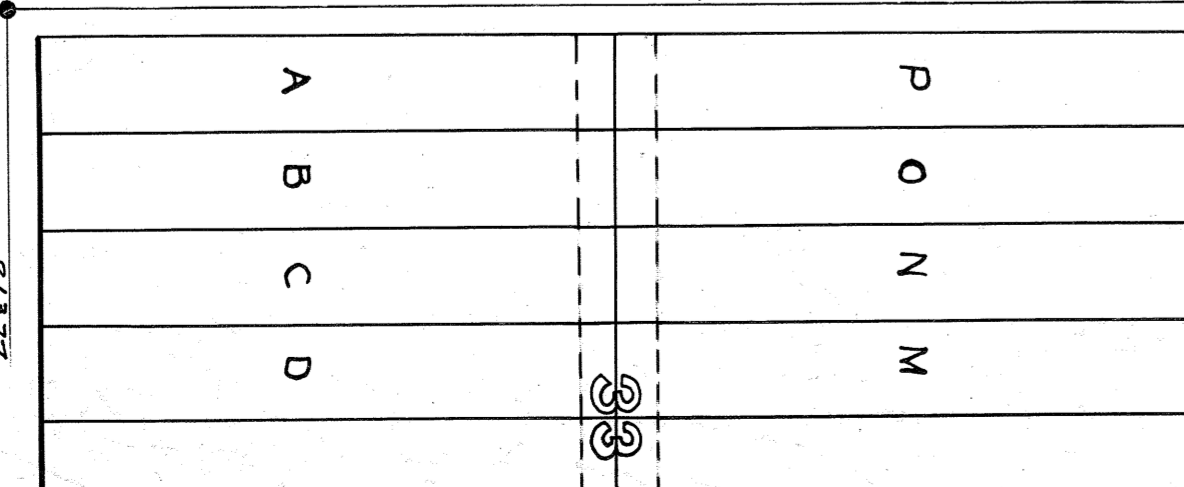
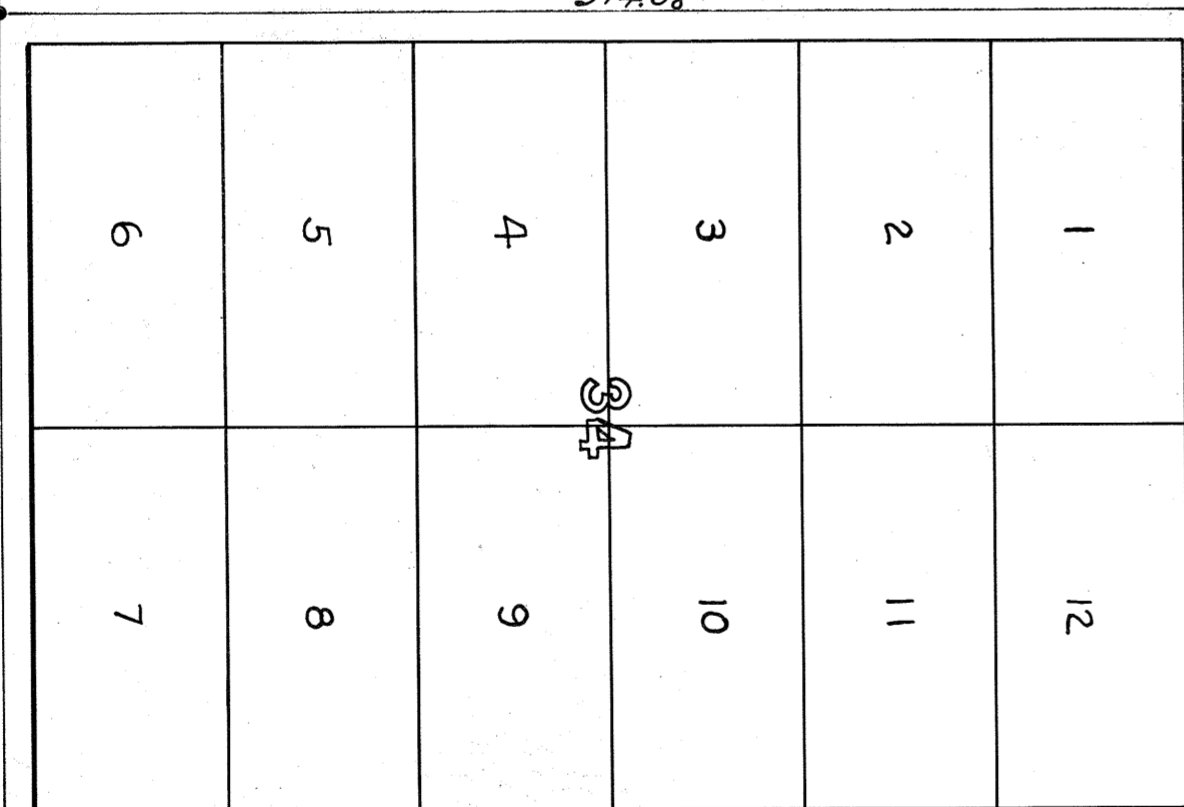
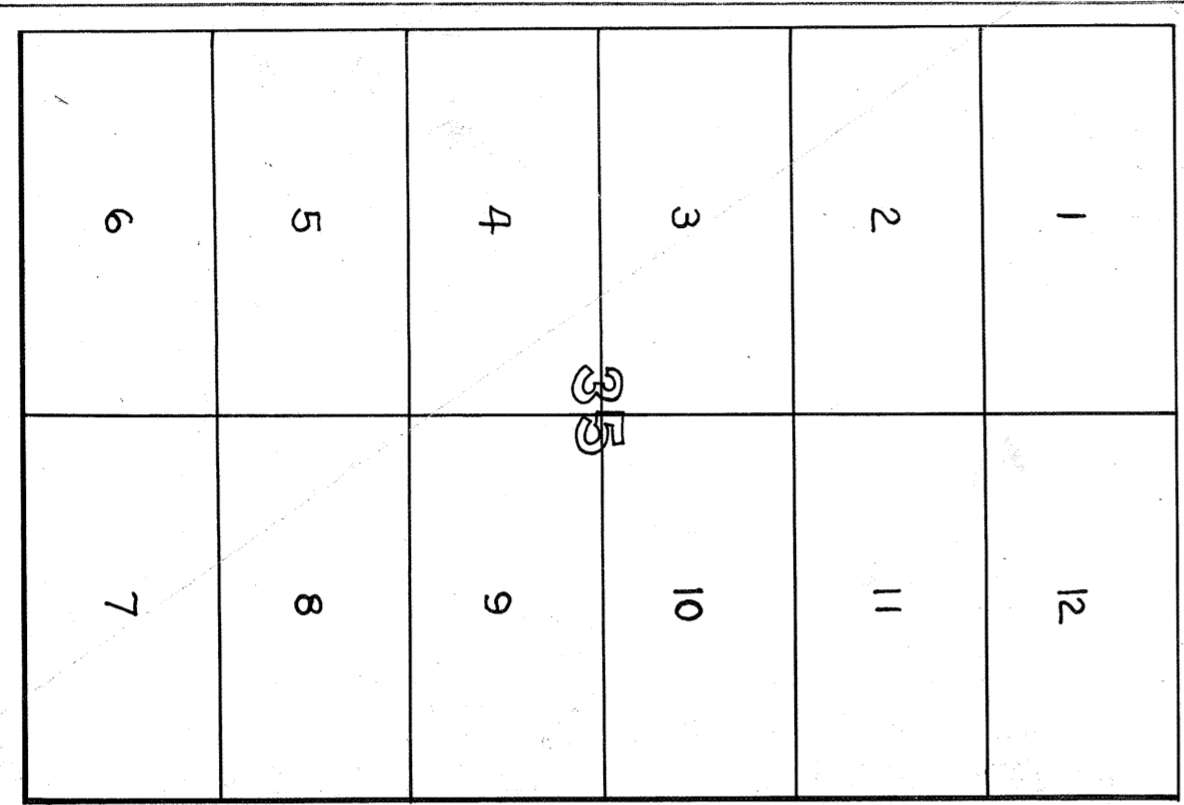
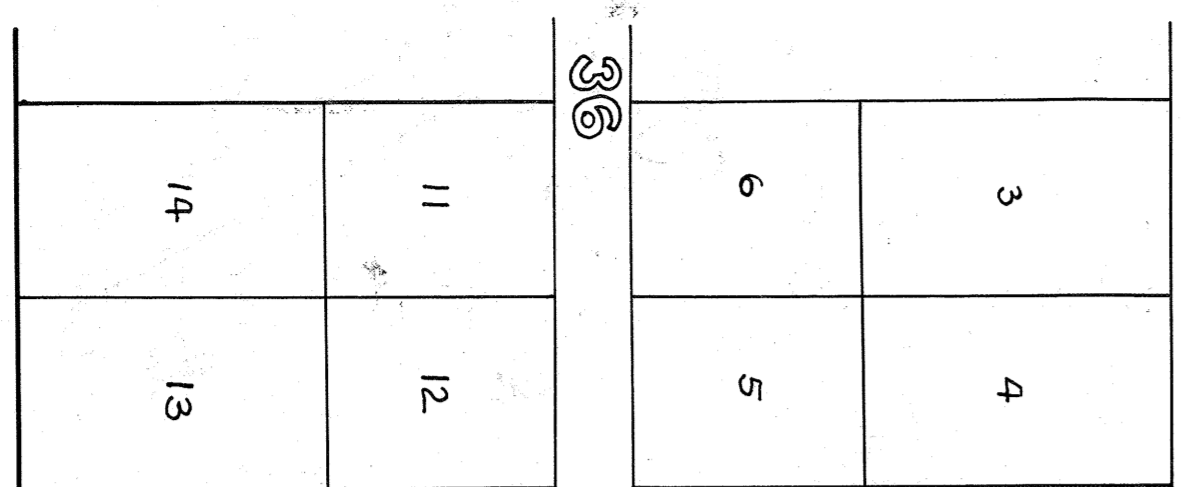
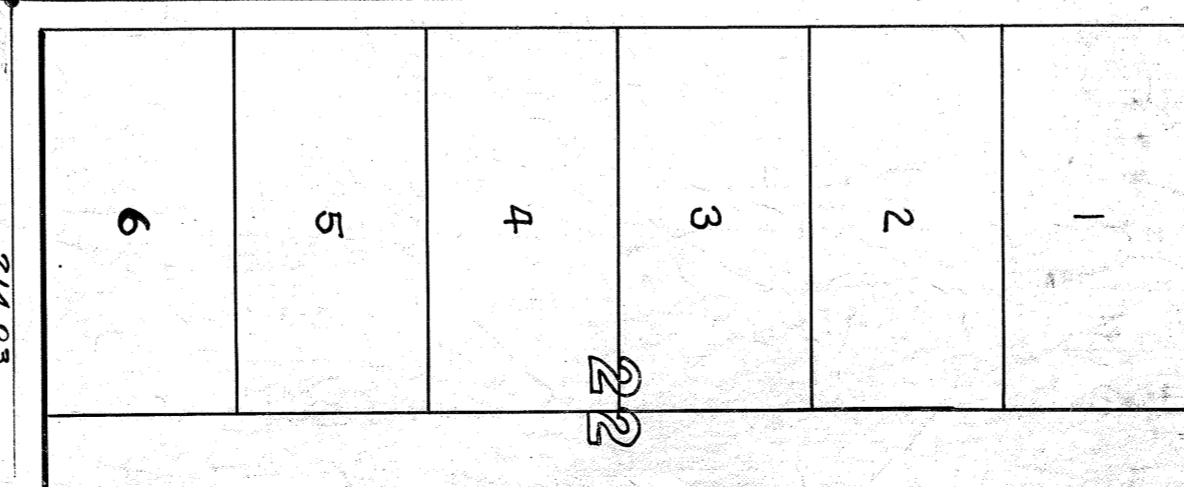
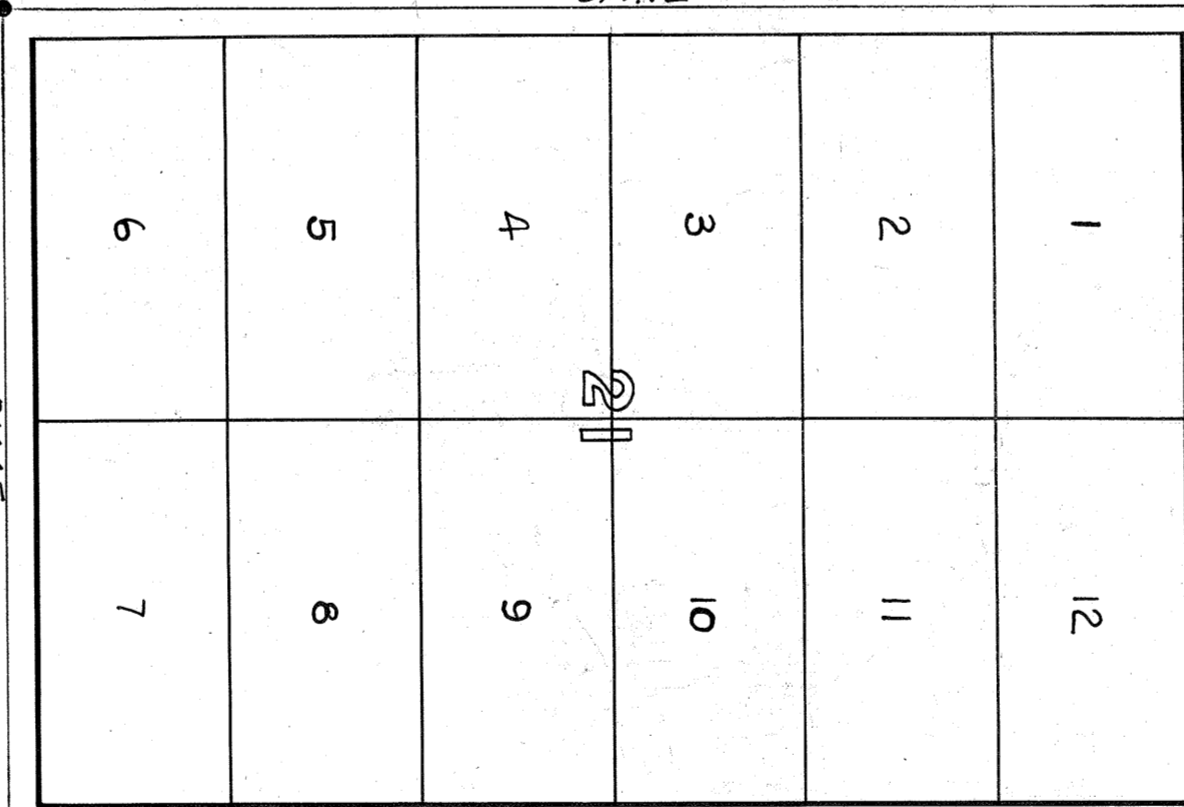
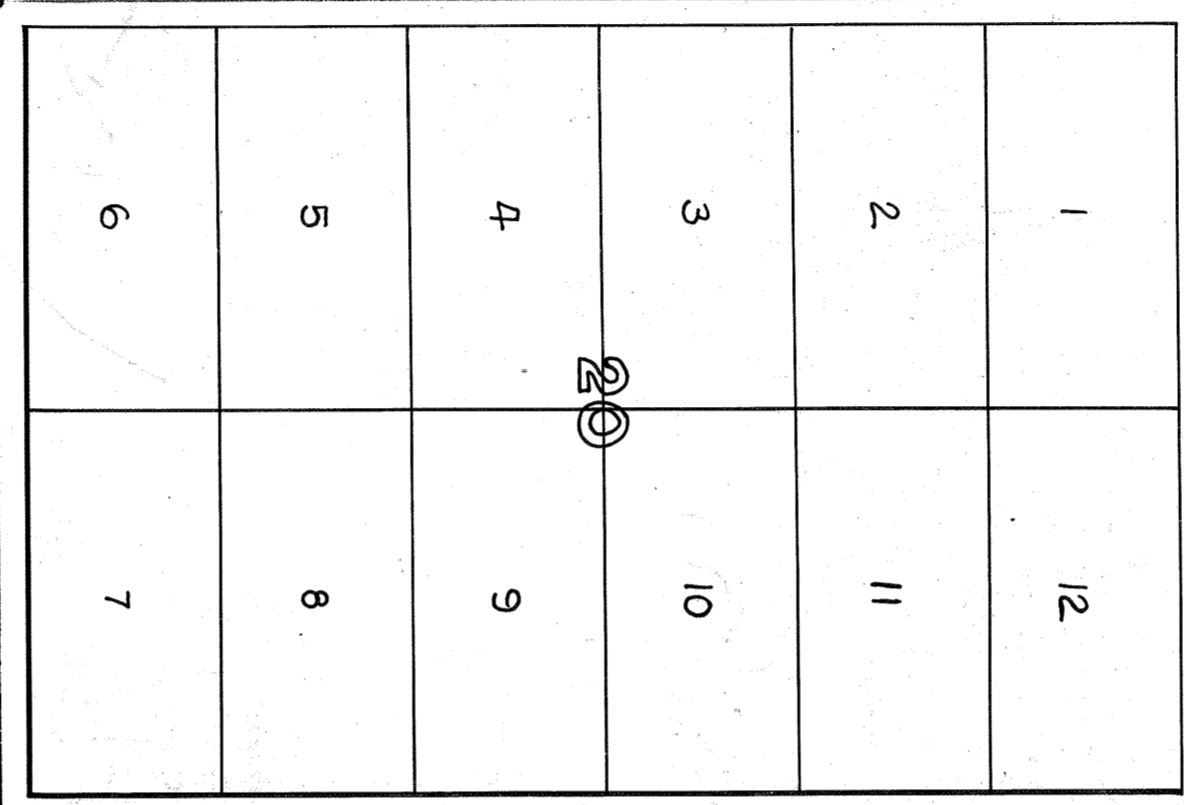
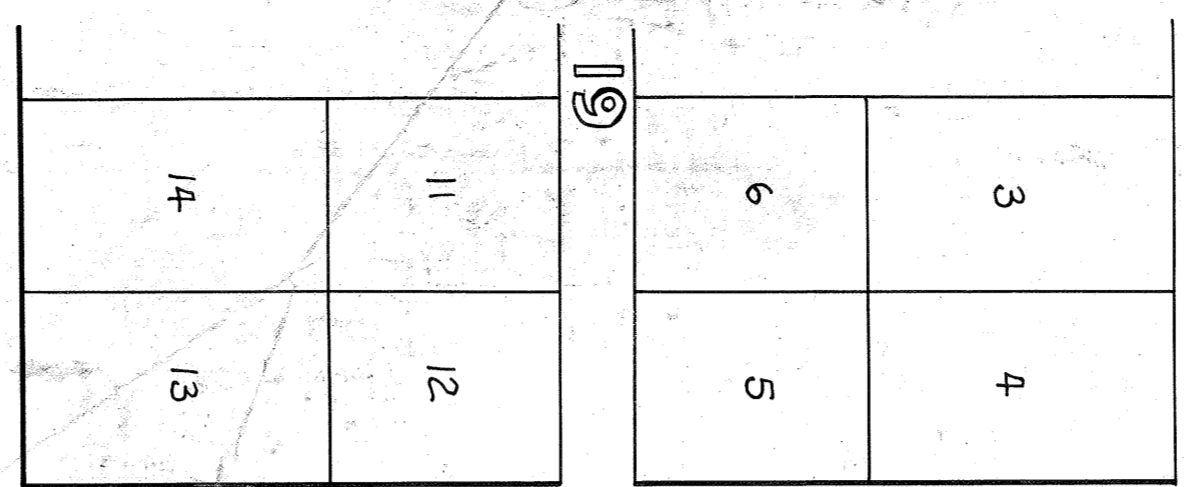
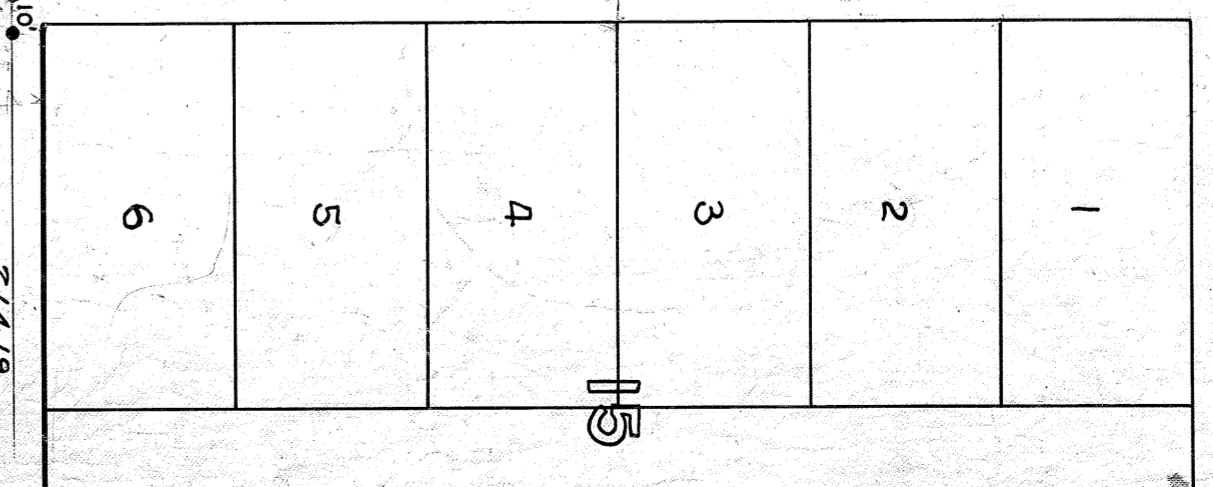
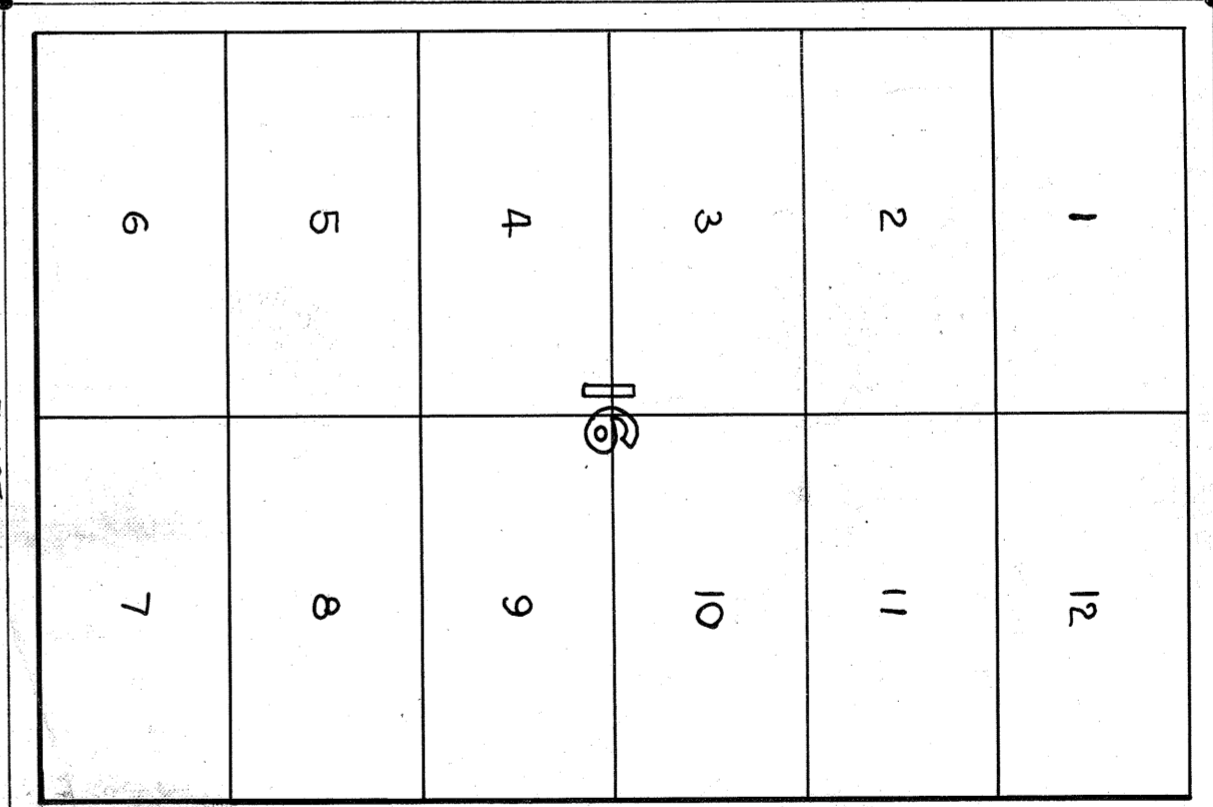
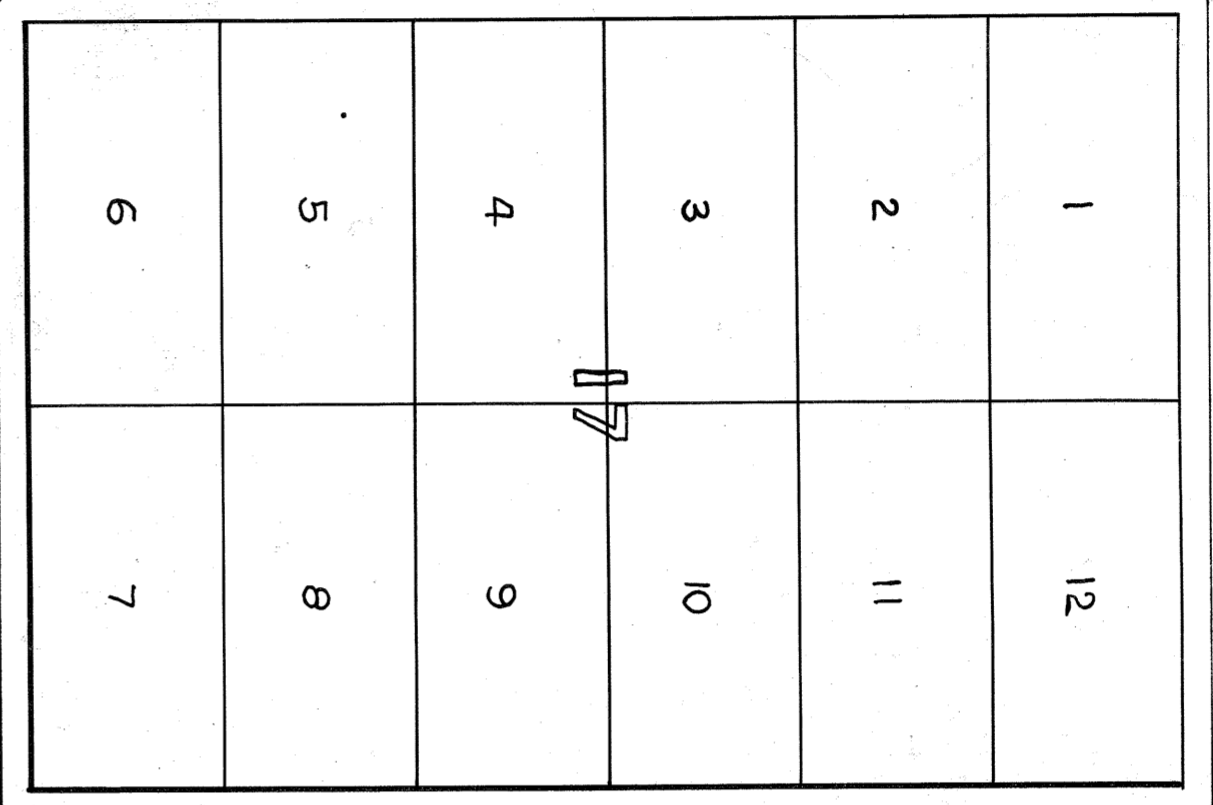
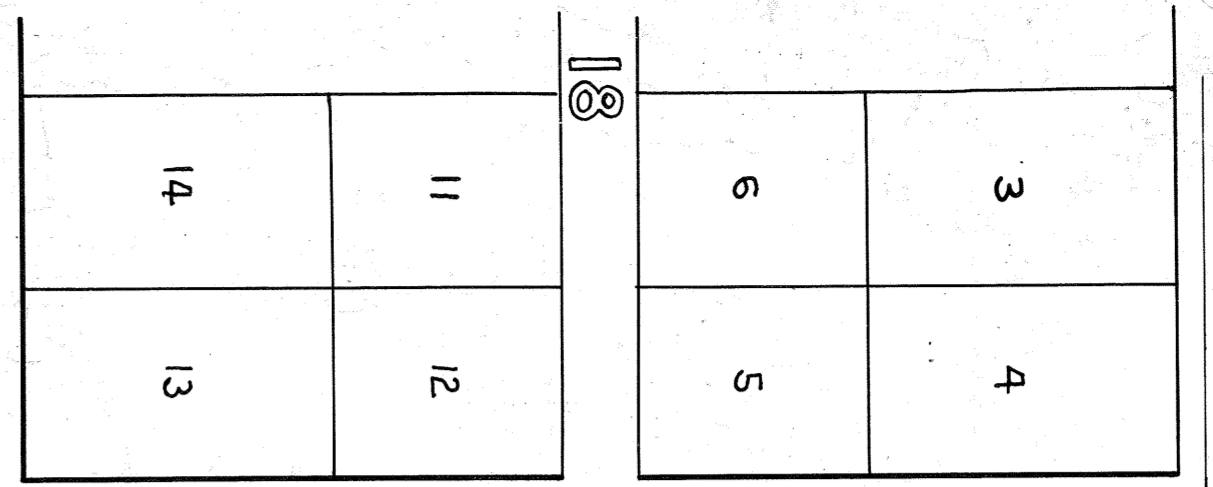

15TH.

16TH.

17TH.

ST.

314.51

314.52

314.48

314.53

314.61

314.58

313.96

313.98

314.03

314.08

314.20

314.17

380.01

314.02

314.12

314.12

314.20

314.18

313.42

313.58

314.16

314.31

314.83

314.94

214.32

323.60

323.66

324.16

324.23

214.28

214.46

214.36

214.05

214.05

214.35

214.22

213.88

214.41

213.96

213.69

214.46

213.77

213.72

214.48

213.72