

214.36

ST.

324.73

324.80

213.88

ST.

325.26

325.39

213.89

ST.

325.83

325.92

213.91

ST.

MICROFILMED

JAN 24 1963

MARKET

214.35

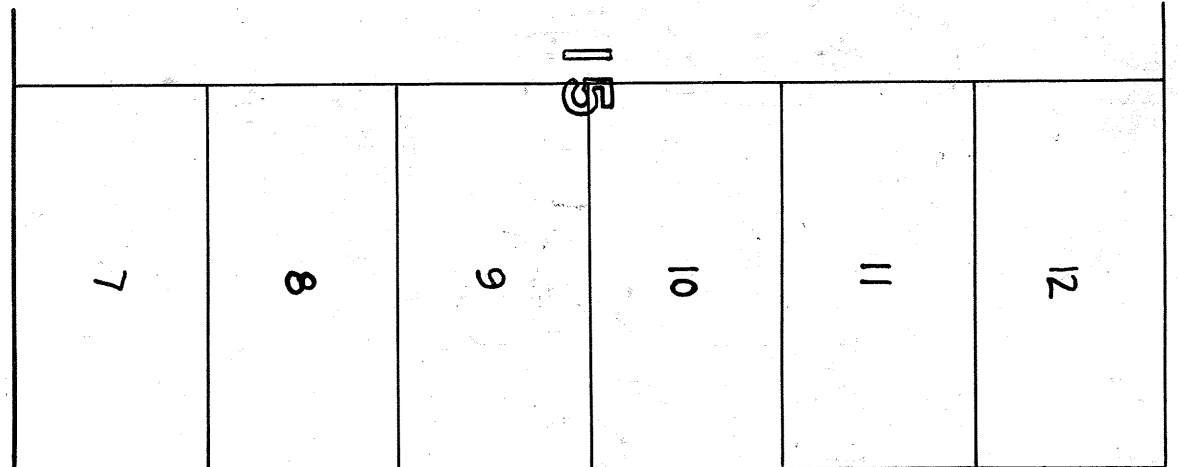

315.63

315.69

213.80

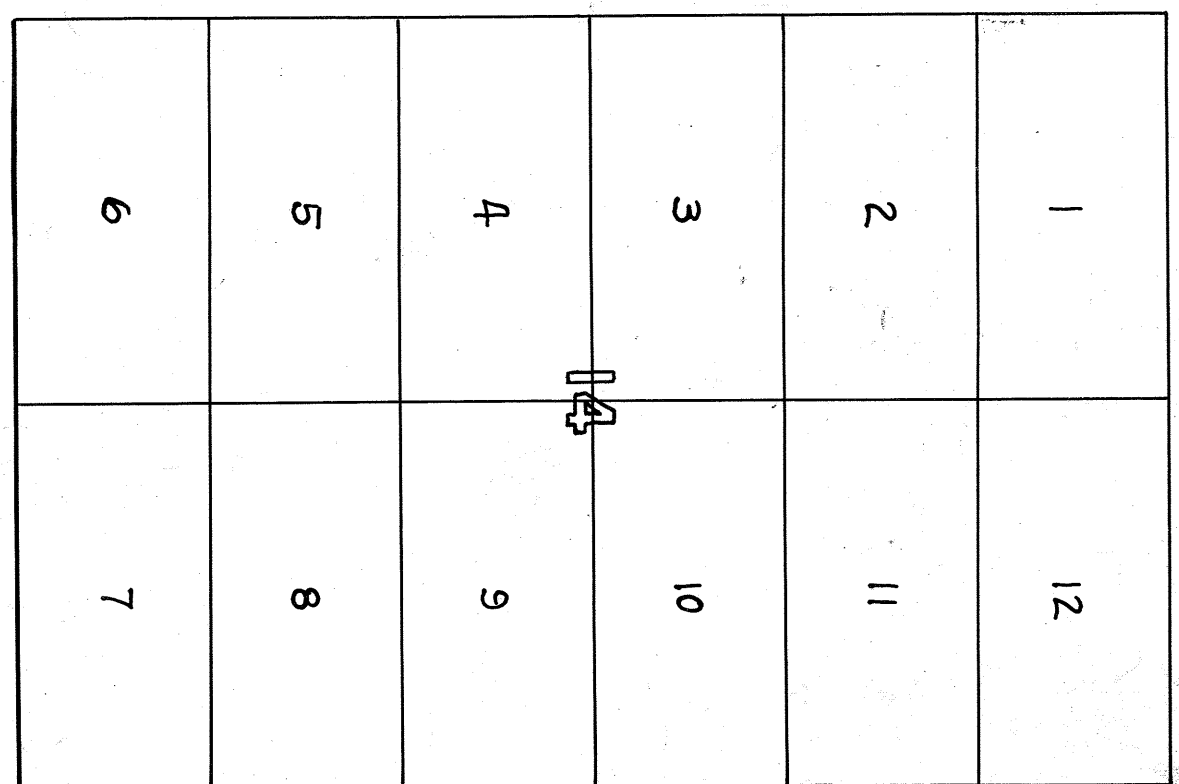

316.52

316.85

213.95

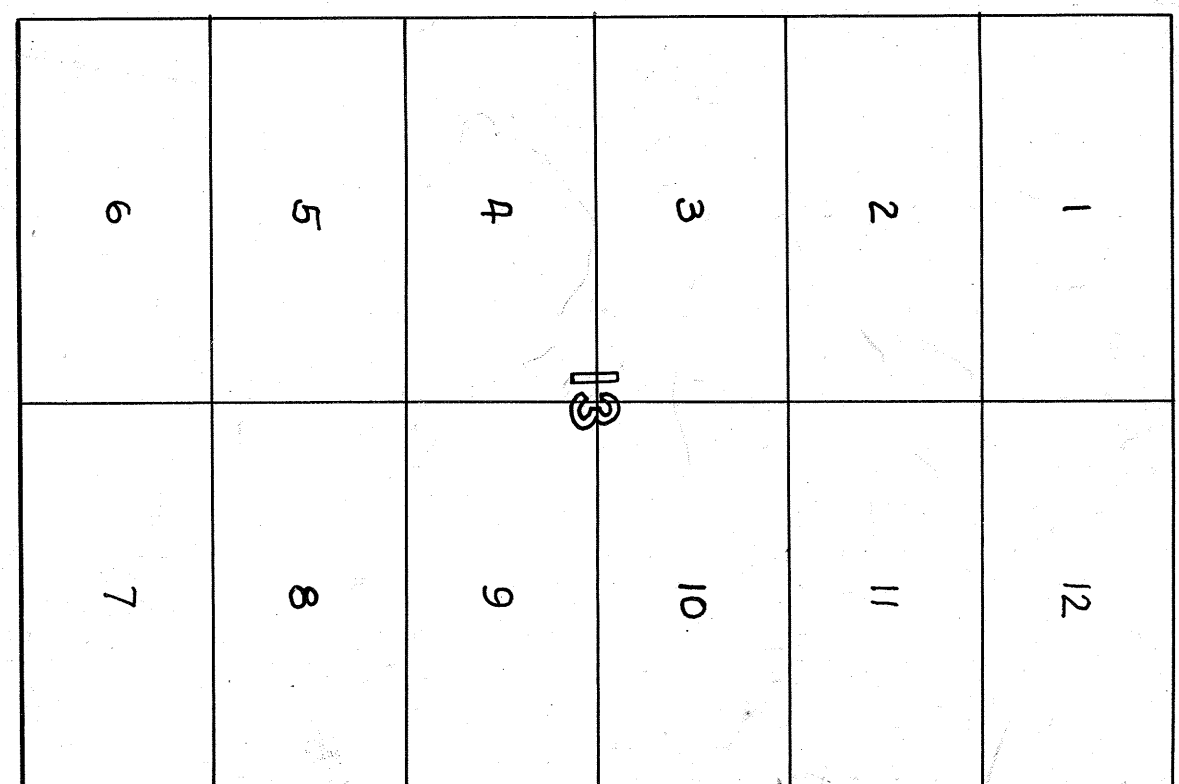

317.40

317.68

213.94

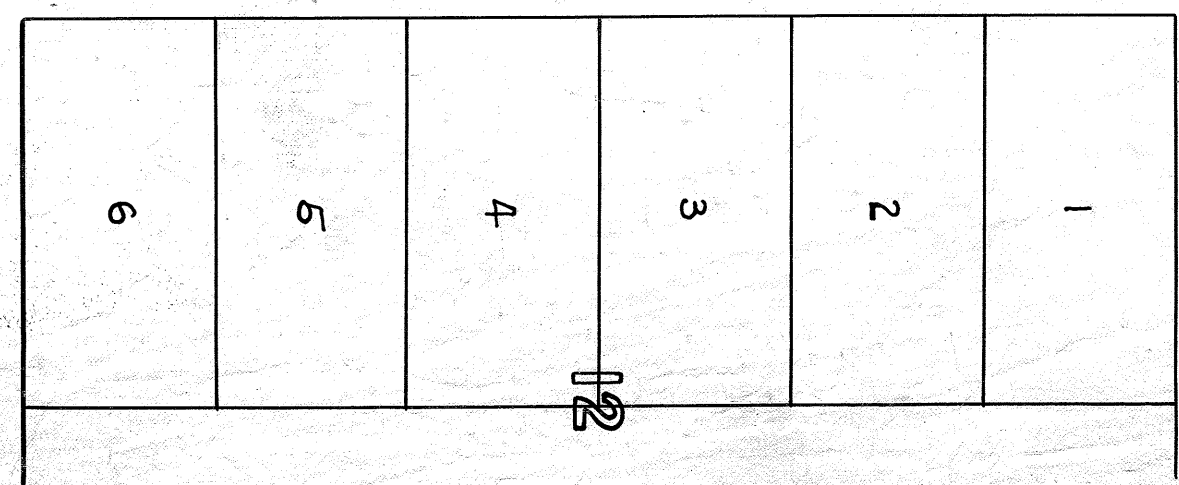

214.19

ISLAND

214.22

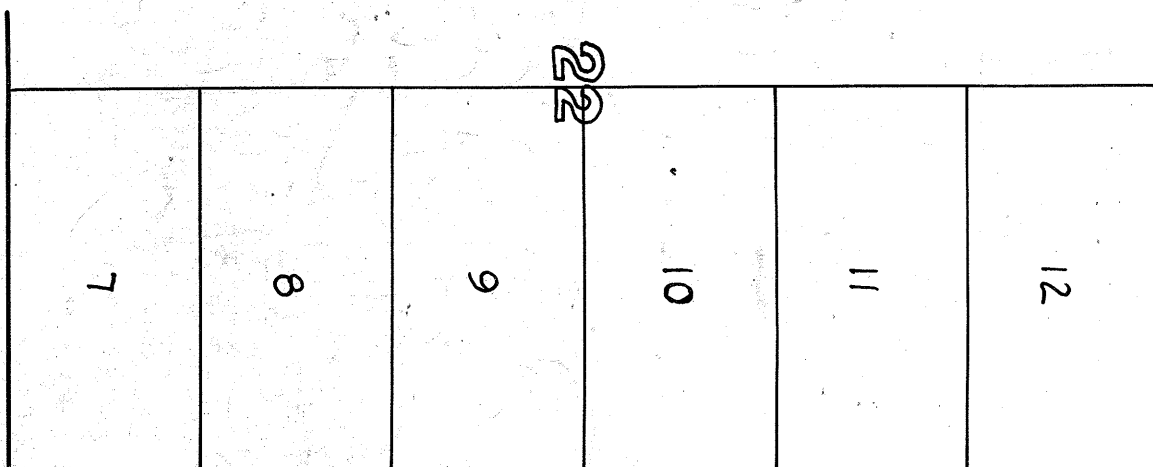

314.06

313.91

213.94

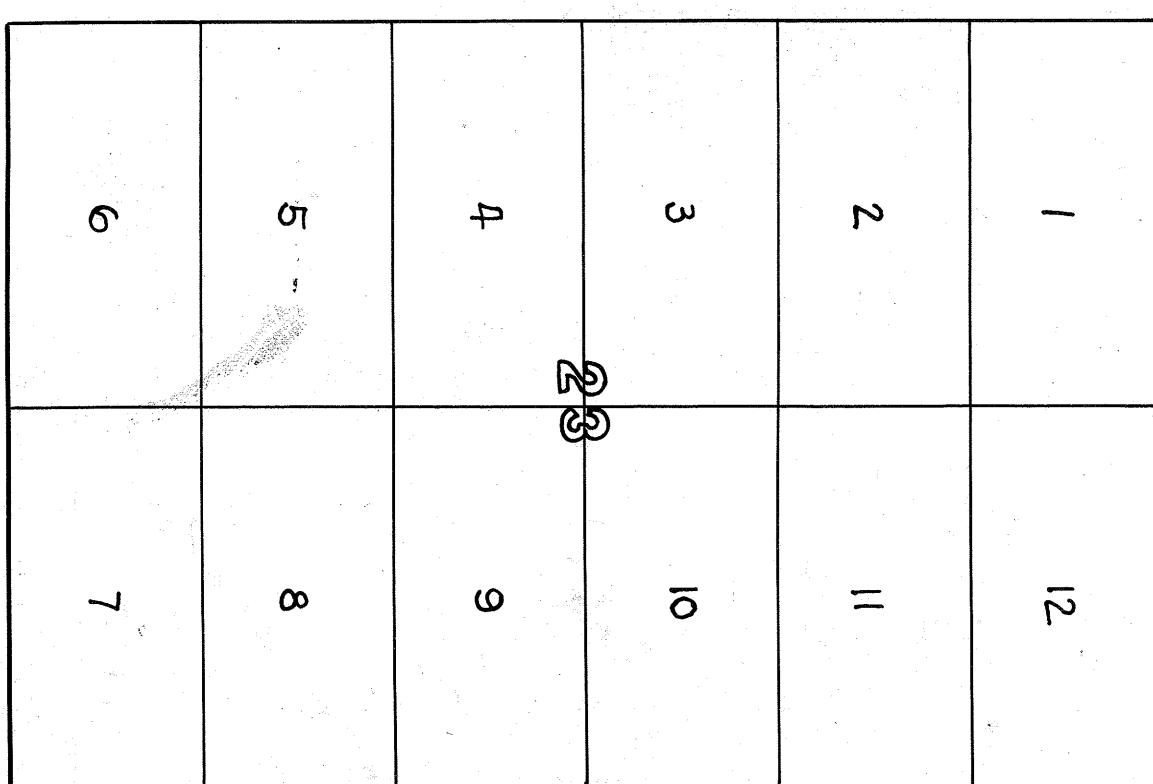

313.80

313.85

214.01

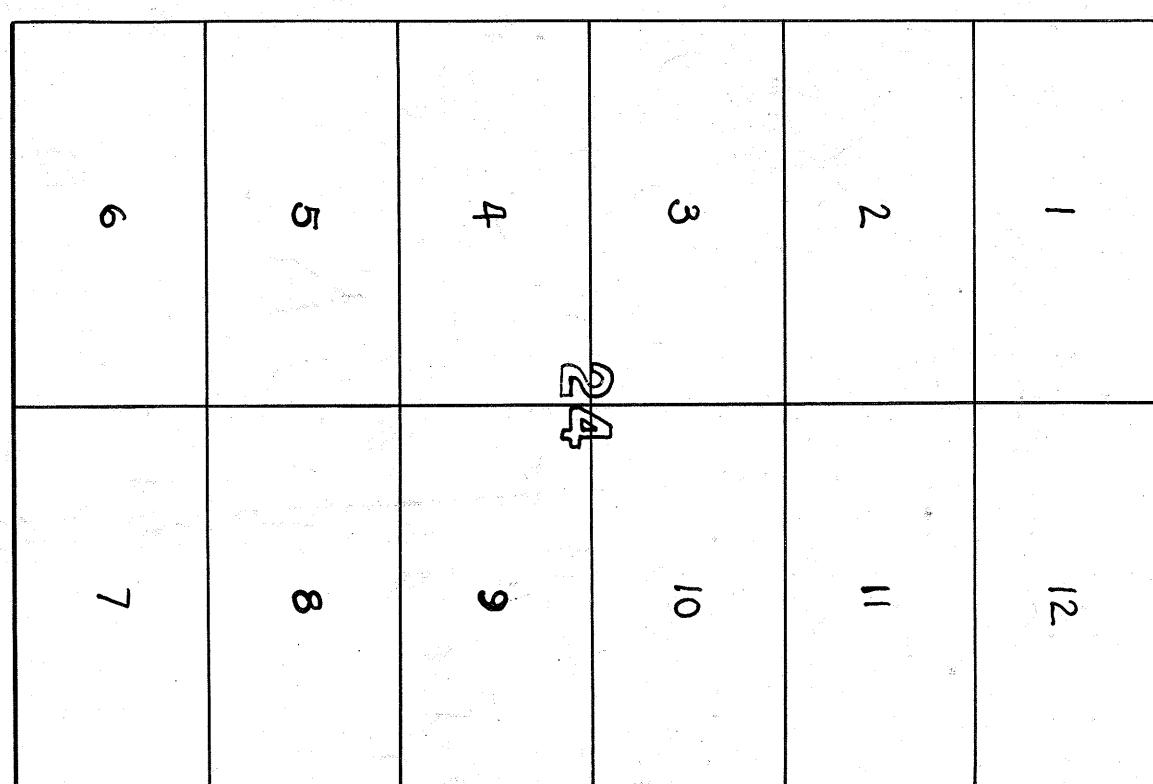

314.06

314.11

213.89

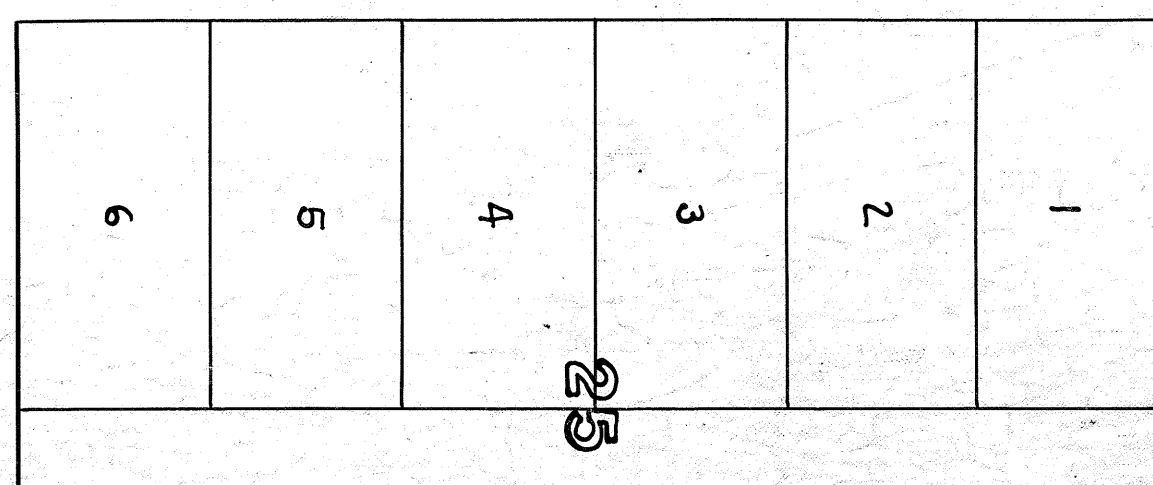

J

213.96

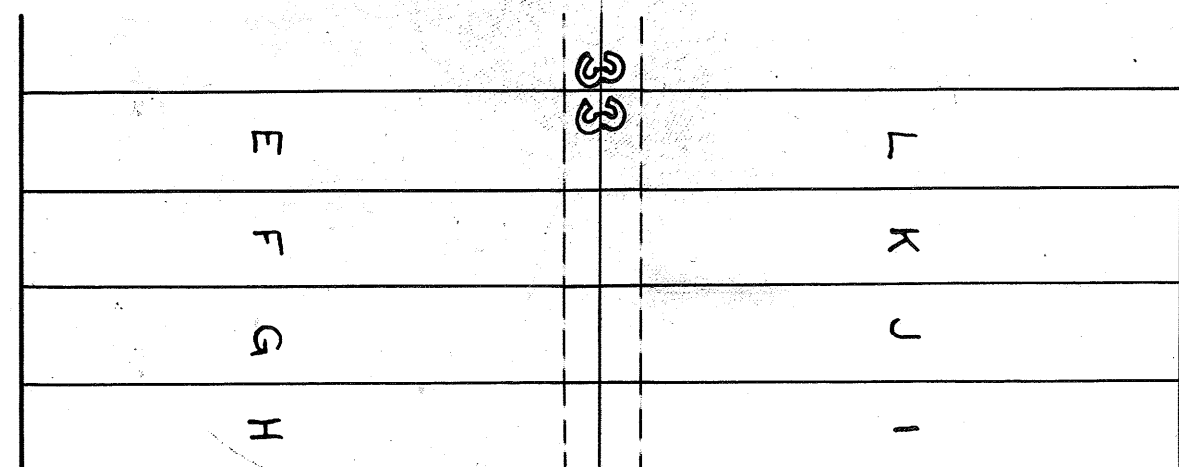

314.36

314.58

214.01

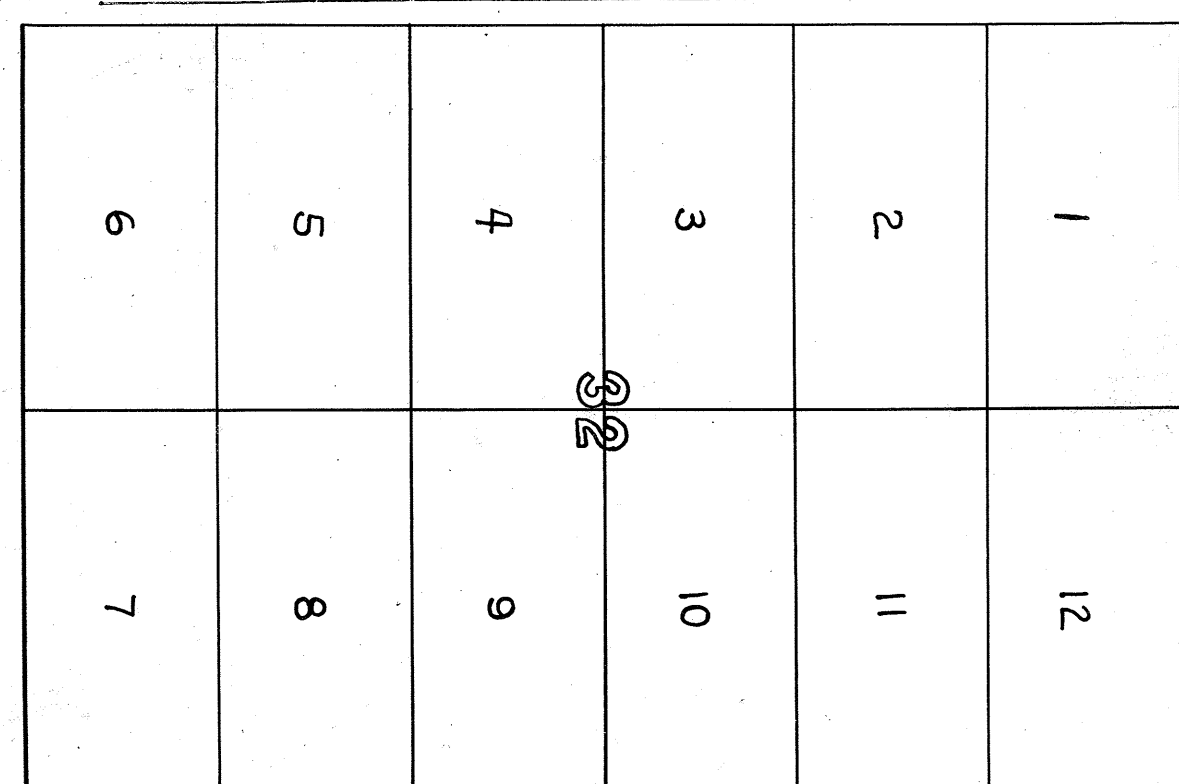

314.63

314.56

213.89

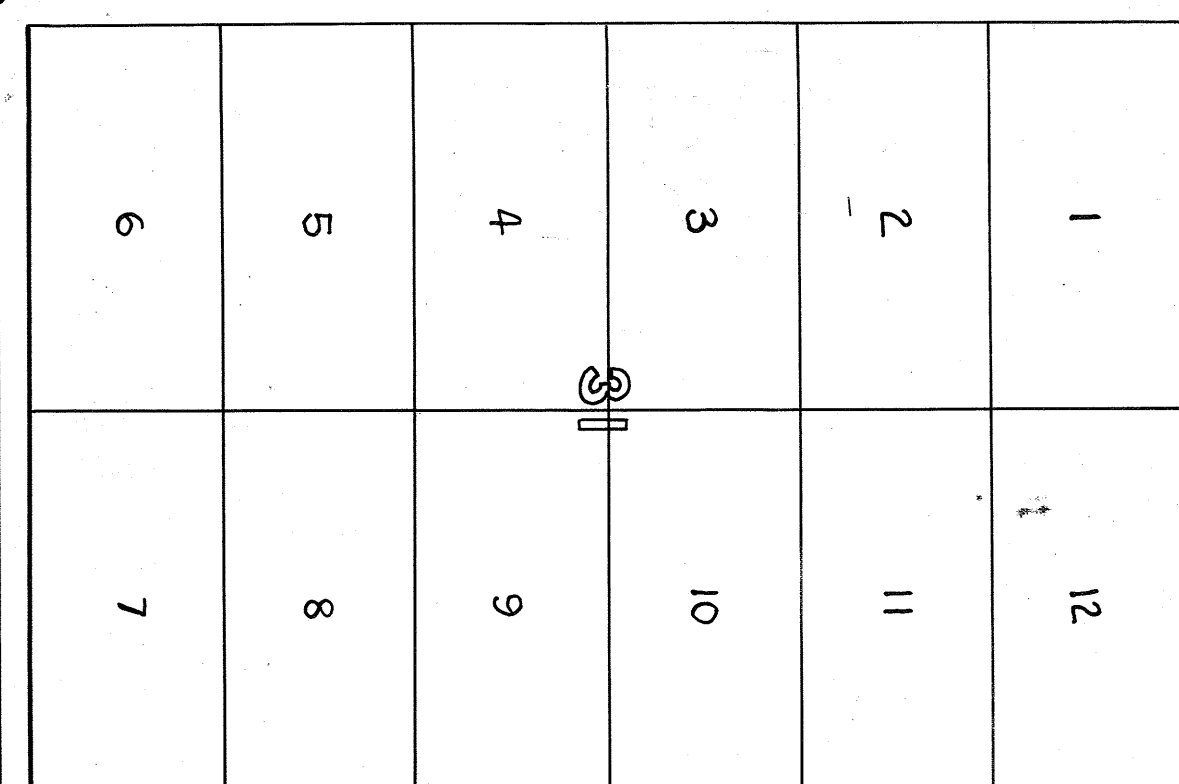

314.34

314.24

214.03

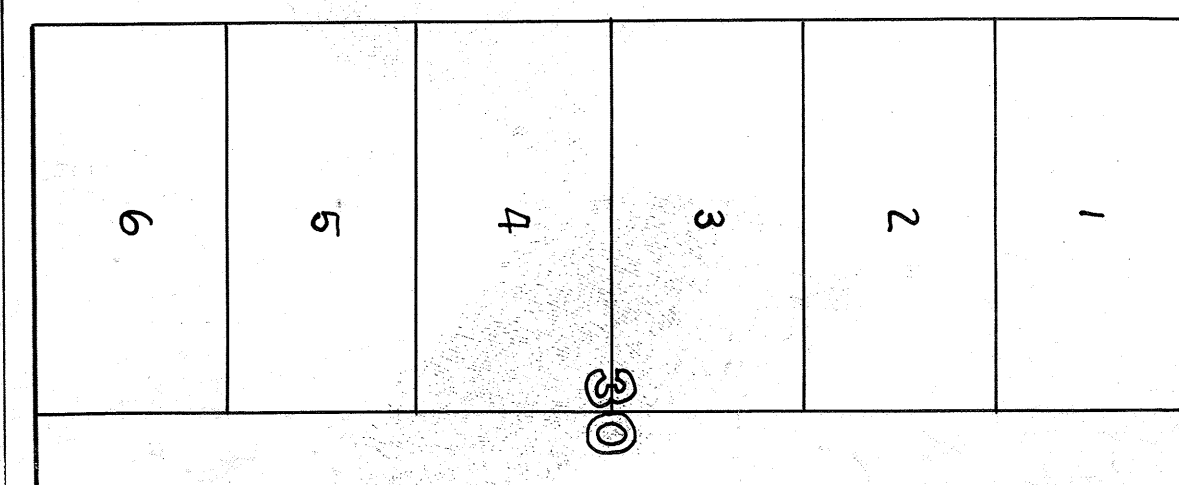

213.72

K

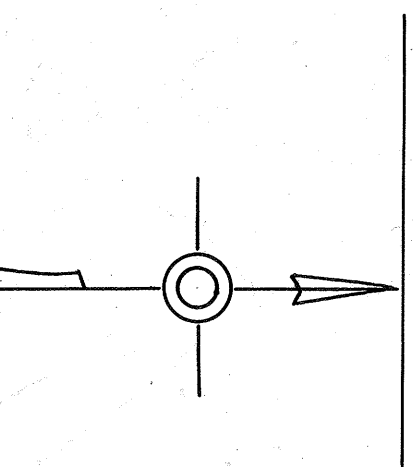

314.59

18TH.

314.62

214.03

314.69

19TH.

314.71

213.92

314.72

20TH.

314.74

214.01

ST.



2/15/50

90A

85

86

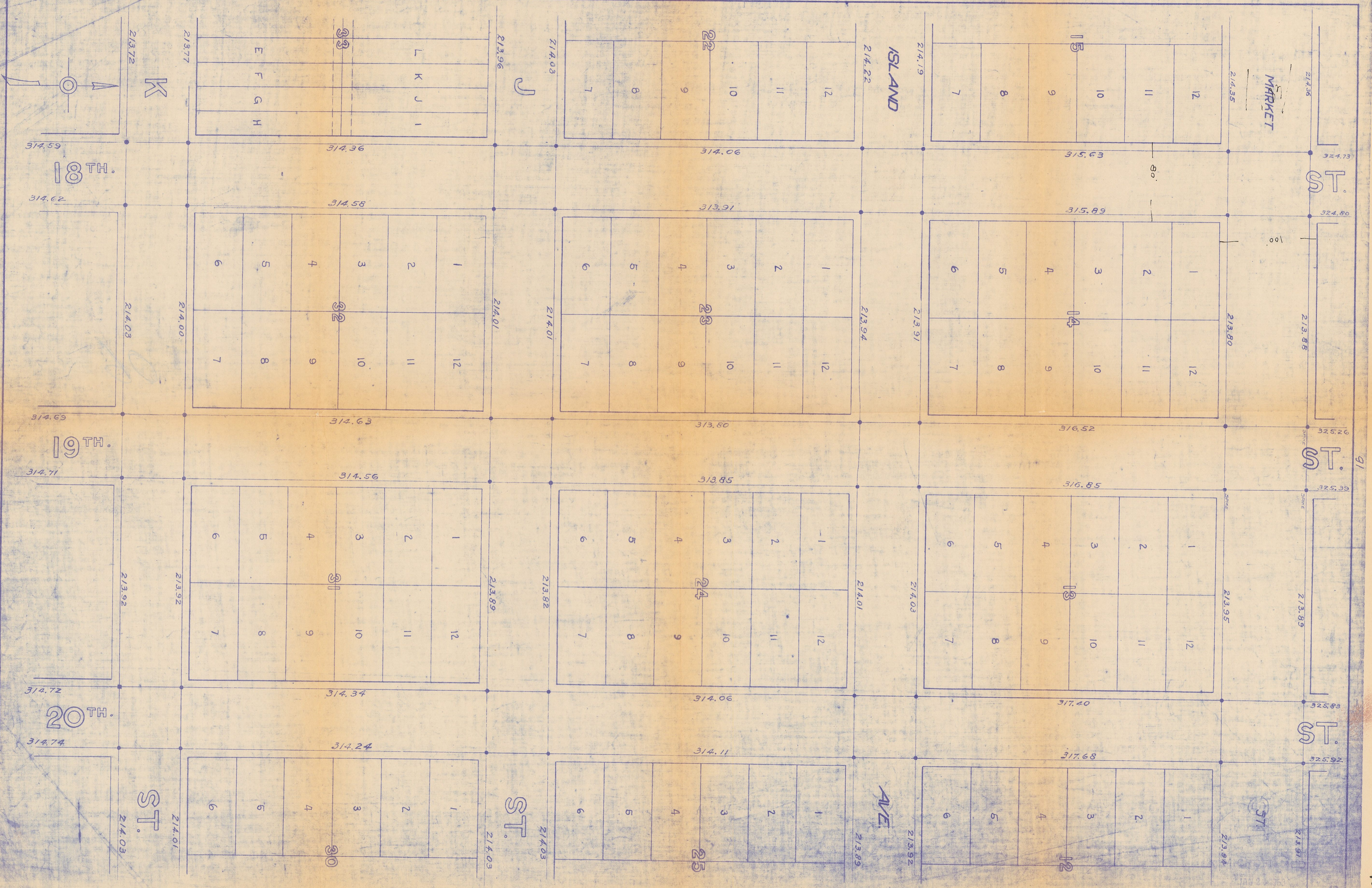

MARKET ST.

ISLAND AVE

18TH ST.

19TH ST.

20TH ST.

K

J

ST.

ST.

AVE

314.59

314.62

314.69

314.71

314.72

314.74

324.73

324.80

325.26

325.36

325.83

326.92

21372

21377

21403

21400

21392

21392

21403

21401

21396

21403

21401

21401

21389

21382

21403

21403

21422

21419

21394

21391

21401

21403

21389

21392

21393

21406

21402

21393

21391

21404

21403

21392

315.43

315.89

316.52

316.85

317.40

317.68

314.06

313.91

313.80

313.85

314.06

314.11

314.36

314.58

314.63

314.56

314.34

314.24

214.35

213.80

213.95

213.94

214.36

213.88

213.89

213.91

90°

100'

90°

ST.

213.91

90A